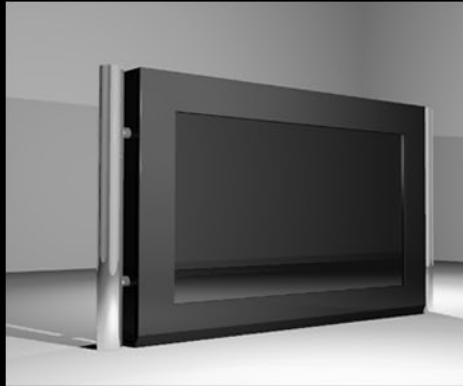

SLABB

**DESCRIPTION:**

The Q-Series is a fully modular digital signage hardware platform. Our unique skin system allows for interchangeable fronts. The Q-series product has four different configurations:

Display Only: An LCD Monitor encased in a ruggedized steel enclosure with protective glass and no external buttons or cables (completely controlled by remote control).

Display and Touch: same as Display Only, but with a glass anti-vandal touch screen.

Display, Touch, and PC: same as Display and Touch, but with an internal PC (adds depth to form factor).

Display and PC: same as Display, Touch and PC, but without a touch screen.

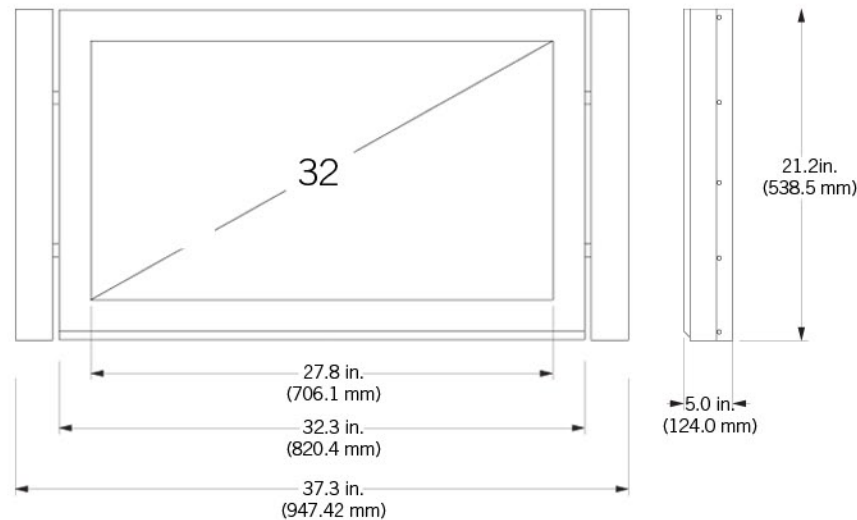
DIMENSIONS:**SPECIFICATIONS:**

Hand Polished Stainless Steel Poles
Ruggedized Steel Case
Powdercoat Finish (in variety of colors)
No exposed buttons, cables
Remote Control
1366 X 768 HD LCD Monitor
VGA, S-Video, HDMI, Component Inputs
6mm Tempered Glass Protecting LCD
20w Internal Amplified Speakers
VESA Mounting Compatible

OPTIONS:

Flat Wall Mount Brackets
Internal Video Player
Internal DVD Player
Internal PC
Internal Touchscreen
Wall Mount
Ceiling Mount
Floor Mount
Array Mount

FINISHES:

Stainless Steel Enclosure
Carbon Fiber Skin
Copper Skin
Aluminum Anodized Skin
Logo Vinyl or Silkscreened

Q32L